

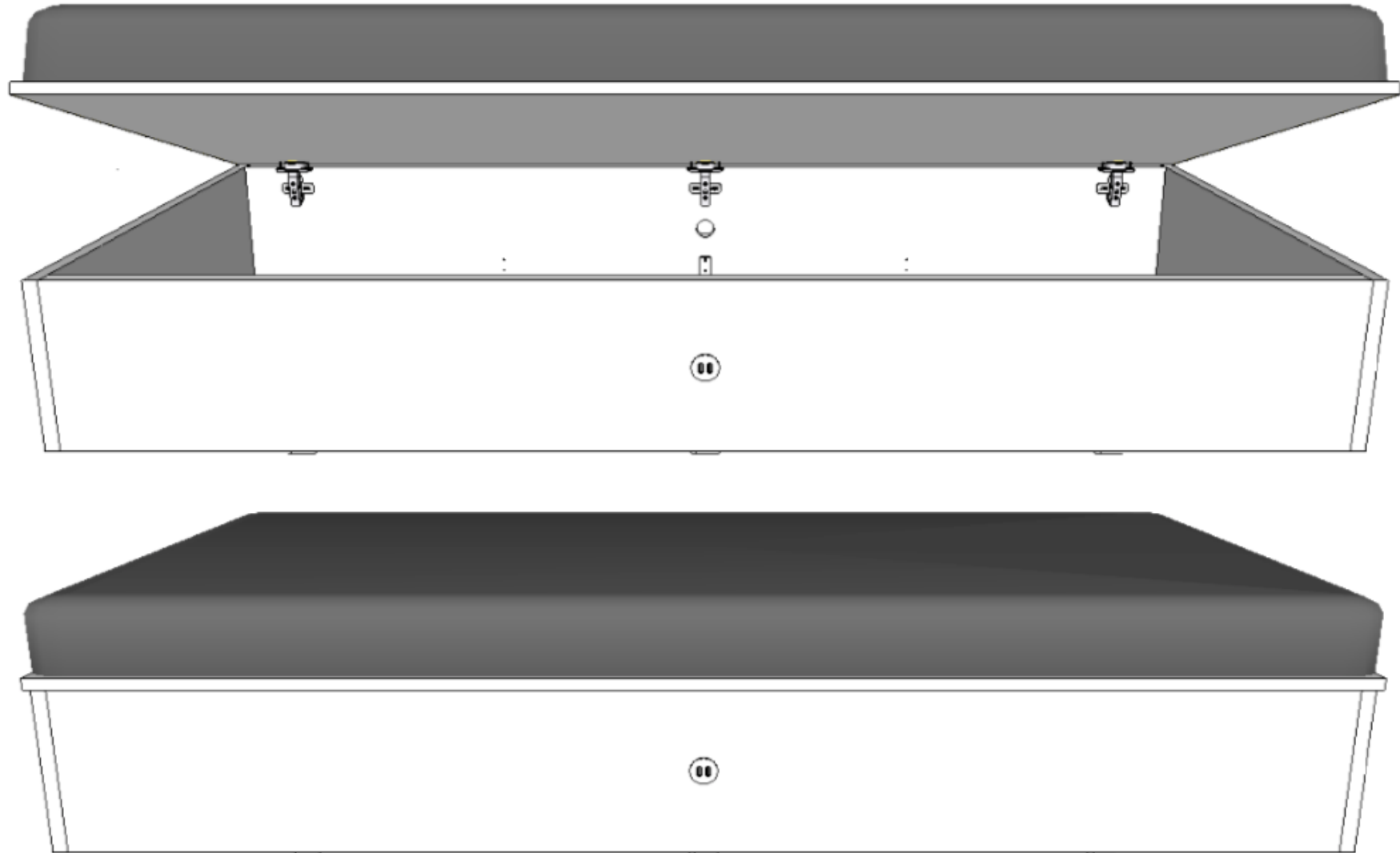

CANAPÉ COFFRE



À SUIVRE **IMPERATIVEMENT** ÉTAPE PAR ÉTAPE !

4mm

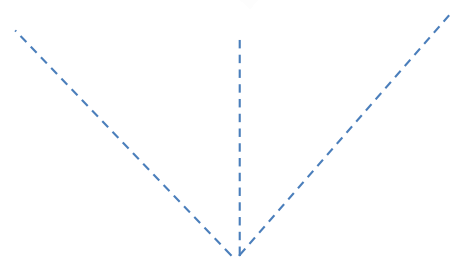
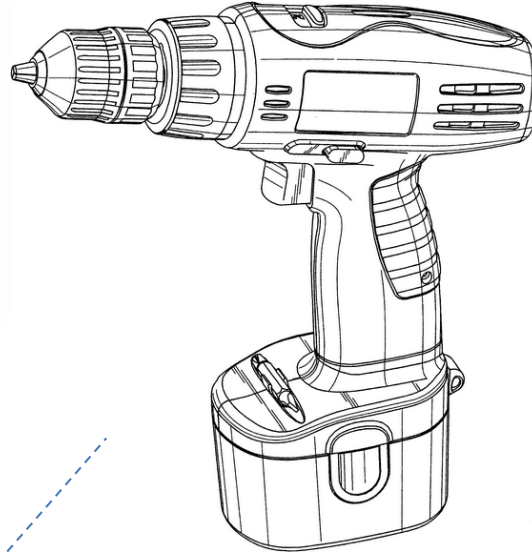
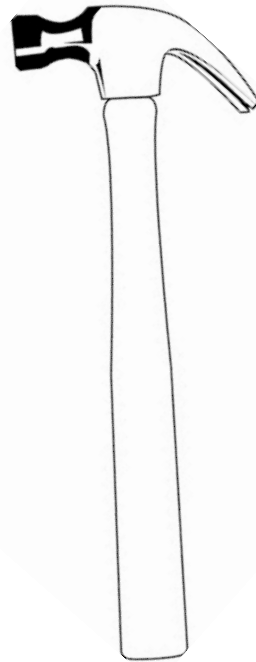







x2

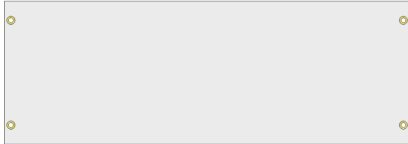

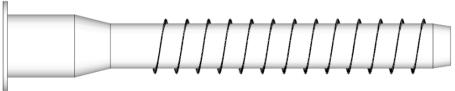
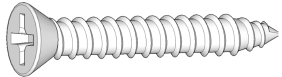
L'assemblage de ce meuble est de la responsabilité exclusive du client

| | | | |
|-------------|-----------|---|------------|
| Carton 1 | SF |  | x 1 |
| | SG |  | x 1 |

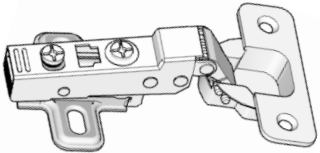
| | | | |
|-------------|-----------|---|------------|
| Carton 2 | SA |  | x 2 |
| | SC |  | x 2 |

| Référence | Image | Besoin | Dispo |
|----------------------------|--|-------------|-------------|
| Vs1 Direkta 7x50 |  | x 8 | <i>x 9</i> |
| Vs2 TF 658 |  | x 16 | <i>x 17</i> |
| Cache vis |  | x 8 | <i>x 9</i> |
| Support |  | x 6 | <i>x 6</i> |
| Pied |  | x 8 | <i>x 9</i> |
| Charnière |  | x 3 | <i>x 3</i> |
| Renfort |  | x 1 | <i>x 1</i> |
| USB |  | x 1 | <i>x 1</i> |

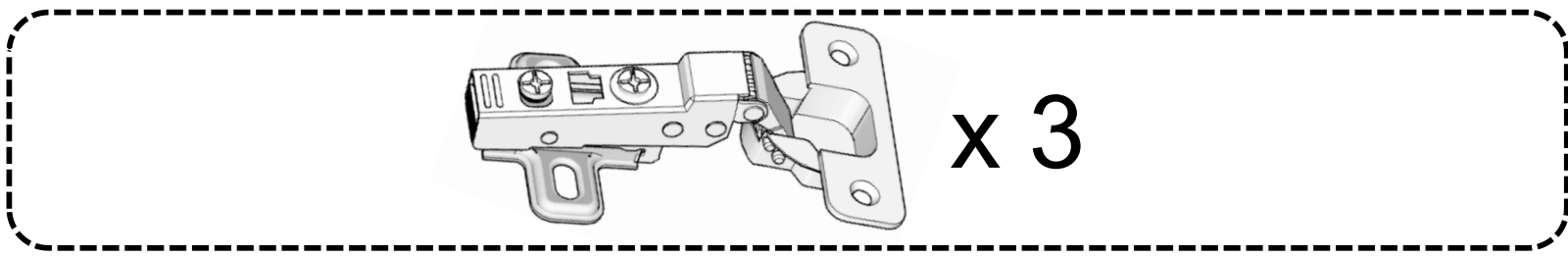

→ Dévisser la **VIS DE MAINTIEN** des charnières et séparer les en 2 parties **A** et **B**

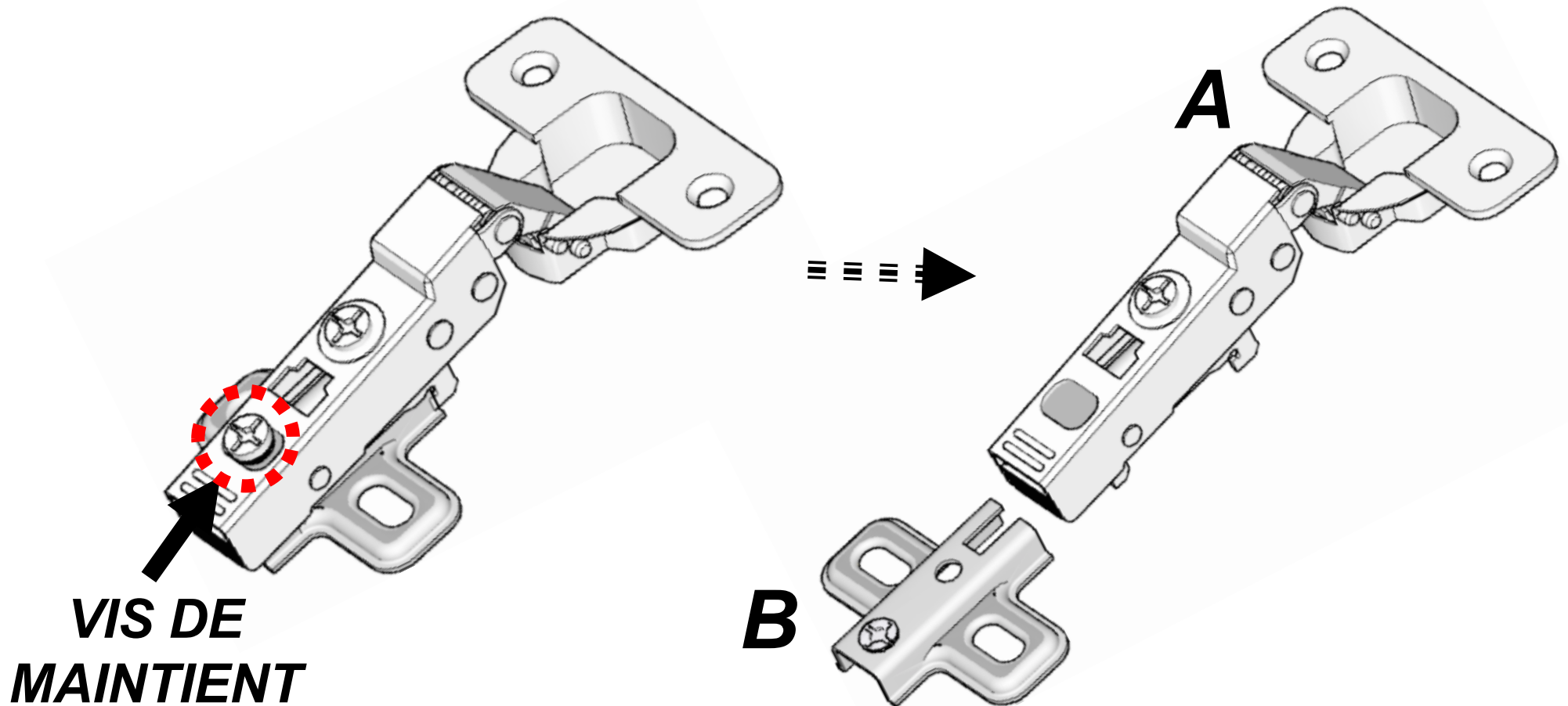

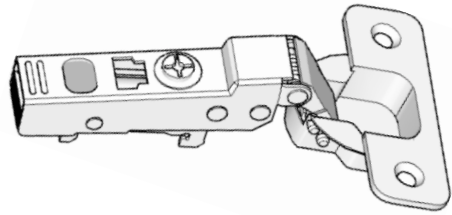

A x 3

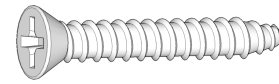

Vs2 x 6

(1) Visser les 3 parties A sur la planche SG

(2) Plier les vers le haut

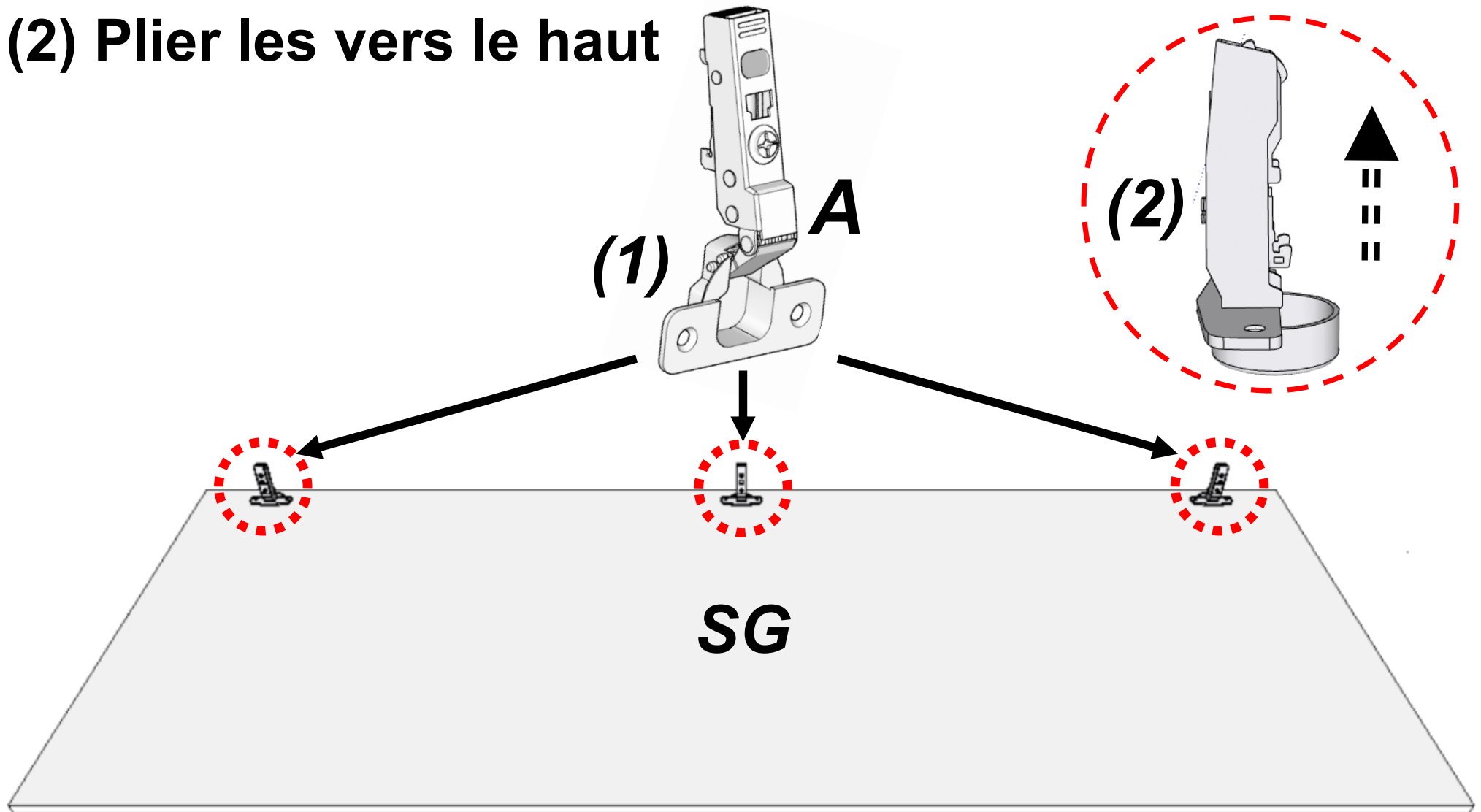

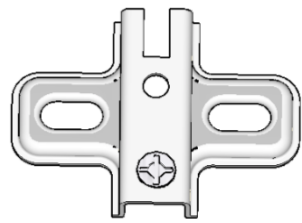

B x 3

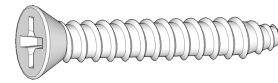

Vs2 x 6

→ Visser les 3 parties B sur la planche SA (vis vers le bas)

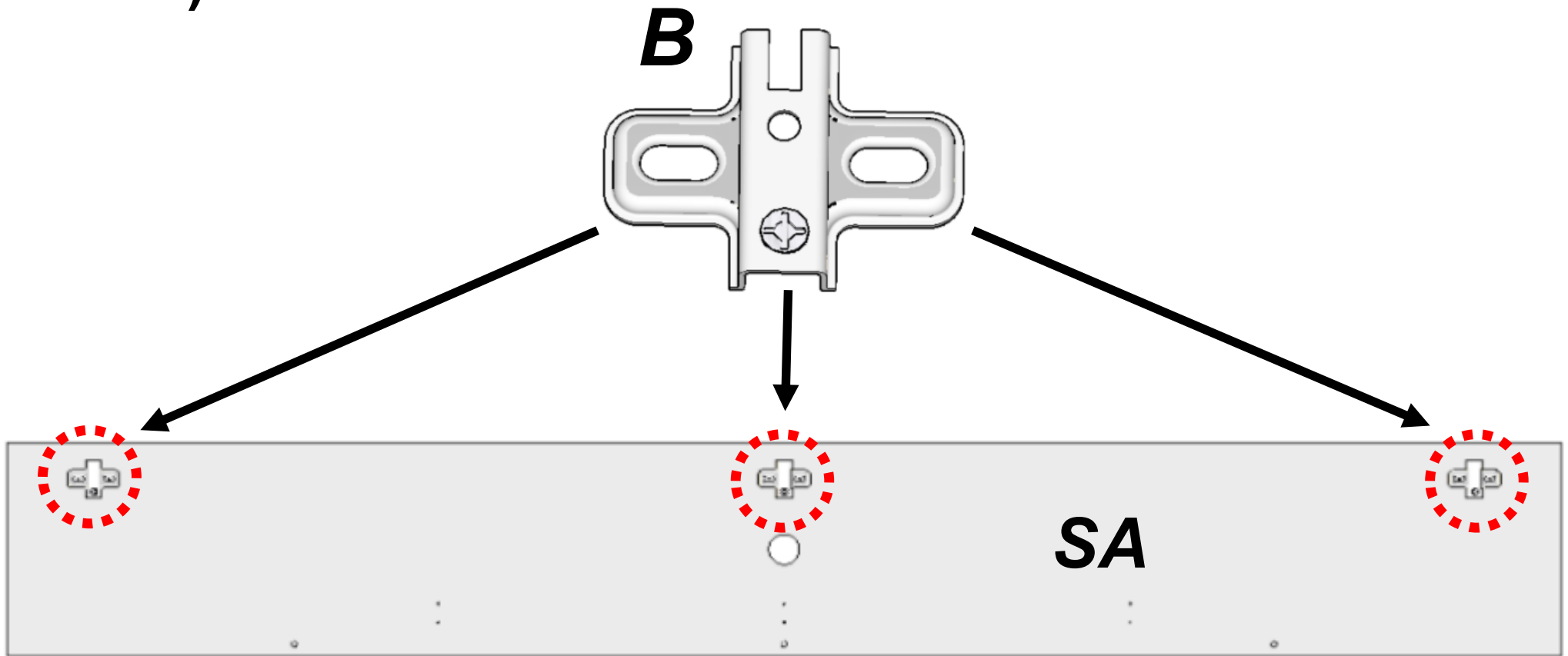

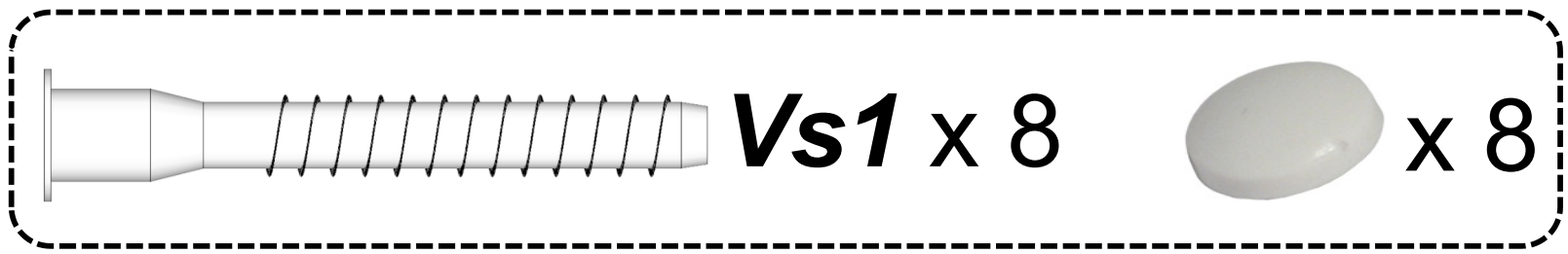

8

→ Assembler SA et SC canapé à l'envers

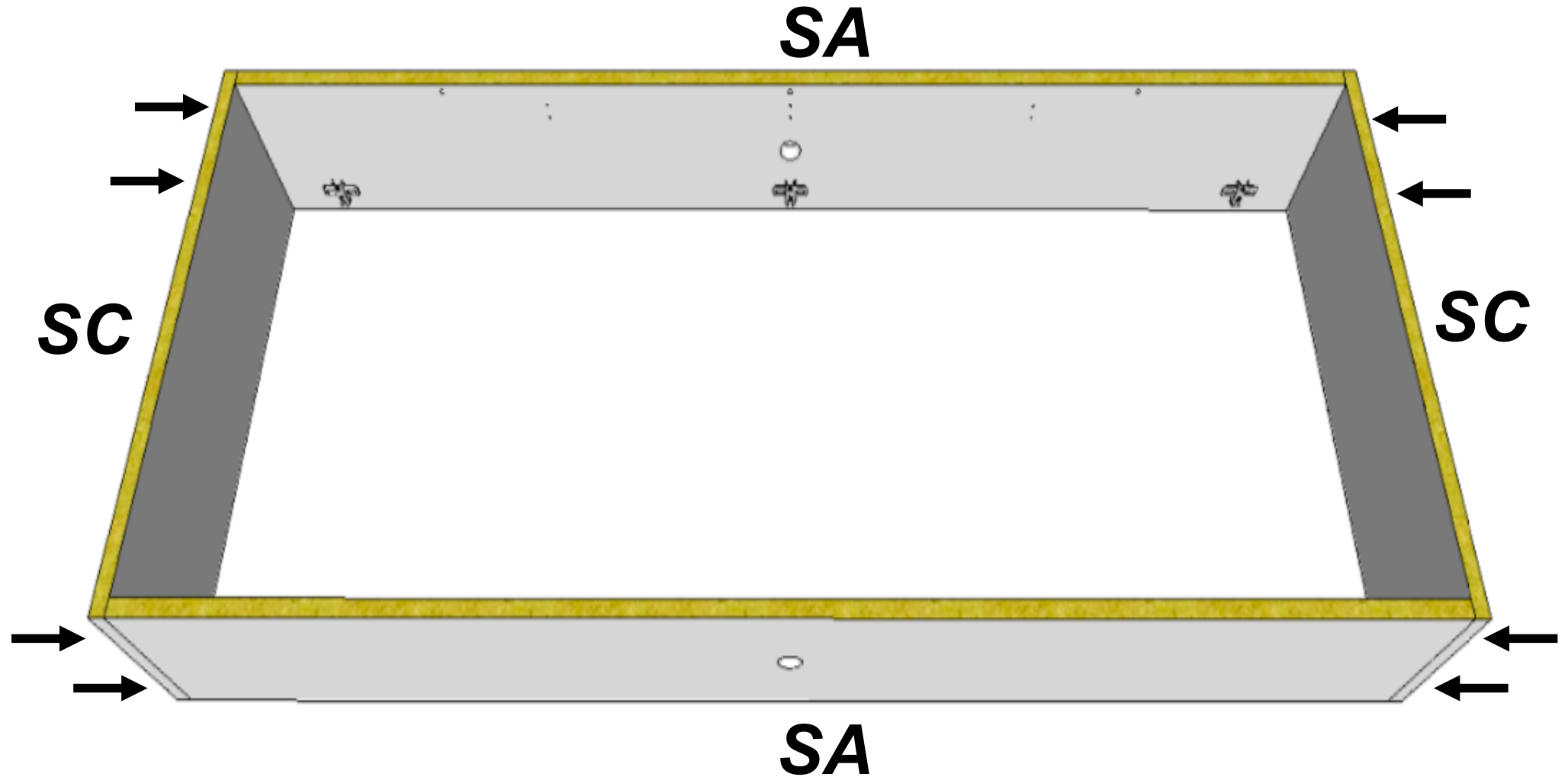

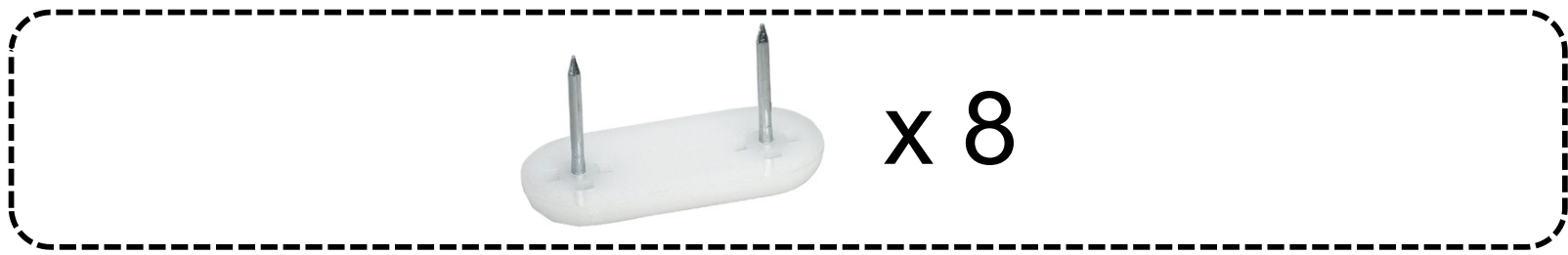

→ Clouer les 8 pieds

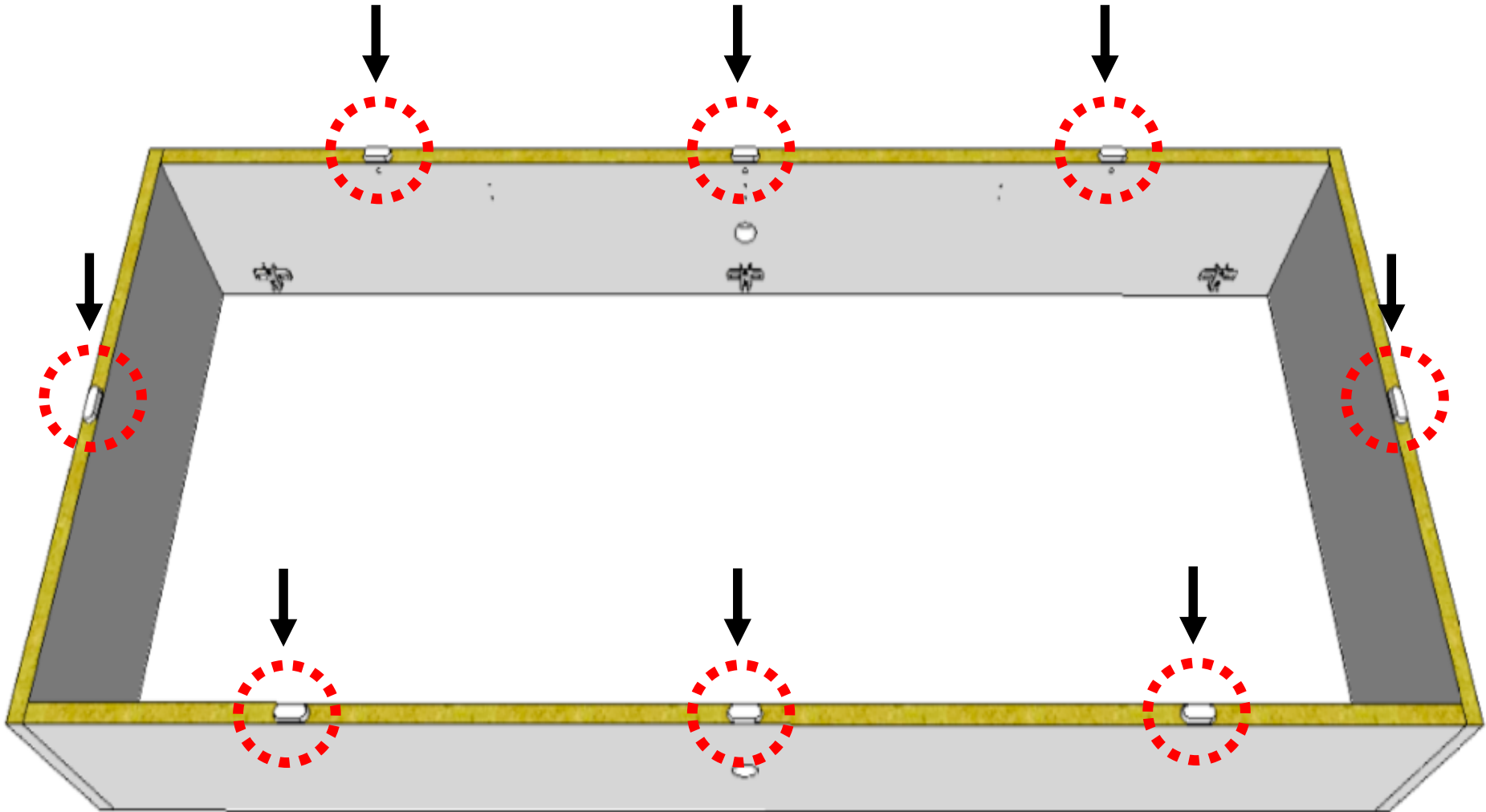

→ Poser le canapé à l'envers sur SG et faire glisser les parties B des charnières dans les parties A

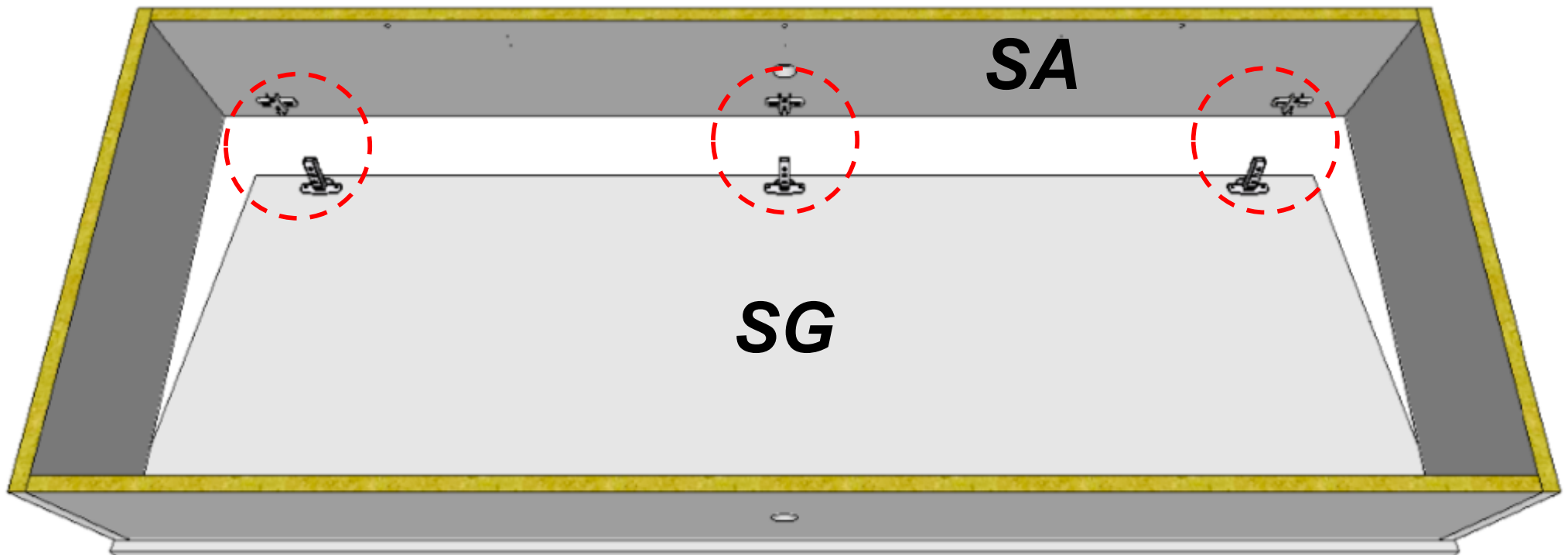
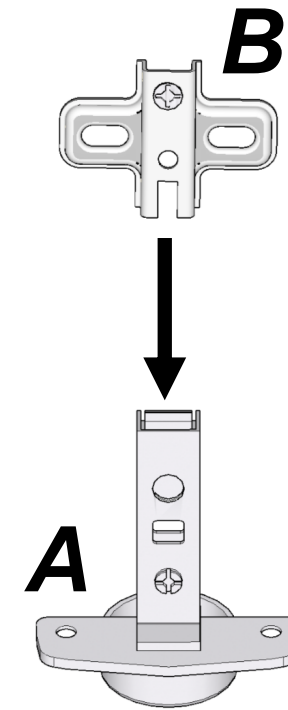

(1) Appuyer fort sur SA pour la plaquer contre SG

(2) Visser la VIS DE MAINTIENT de chacune des charnières

VIS DE MAINTIENT 11

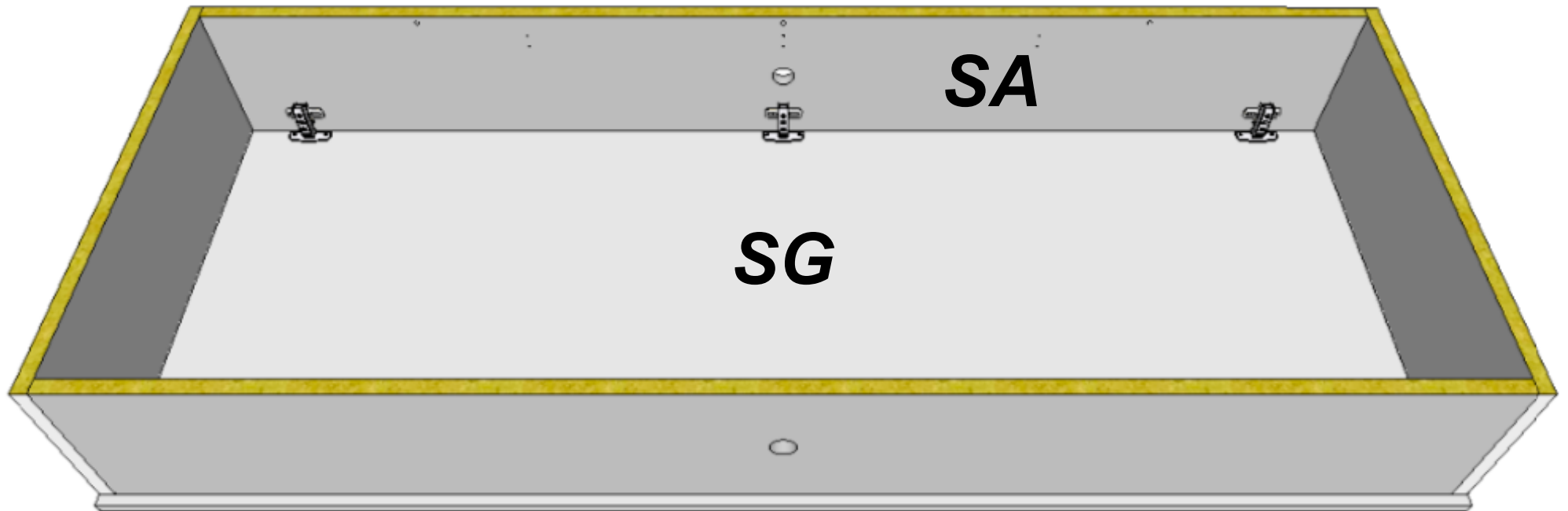
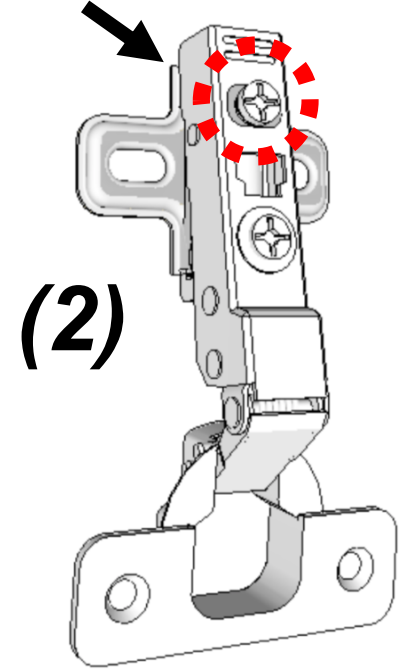

→ Aligner autant que possible SG avec SA en à l'aide de la VIS DE RÉGLAGE (cf page suivante)

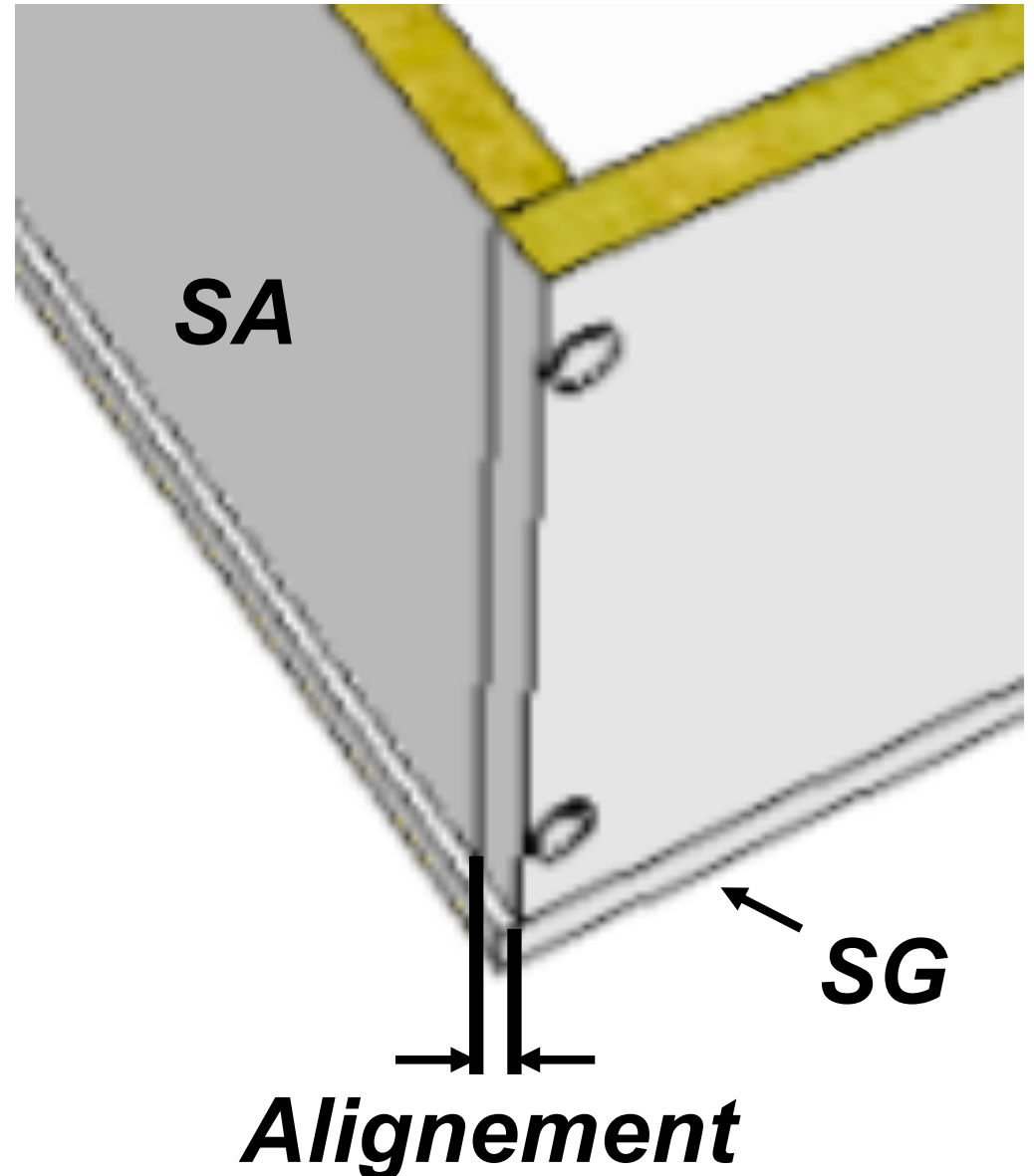
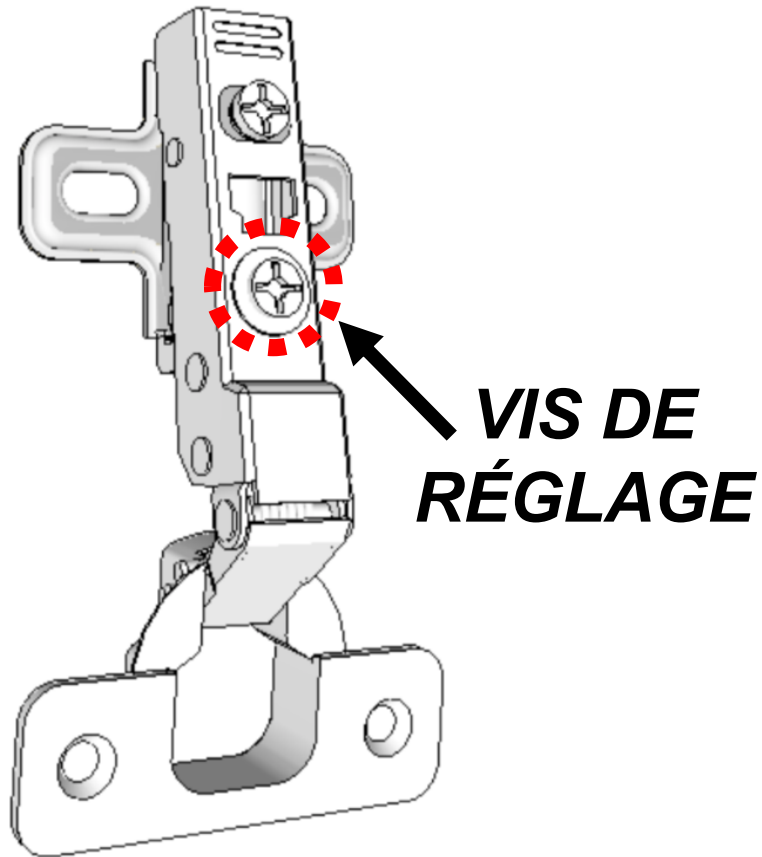

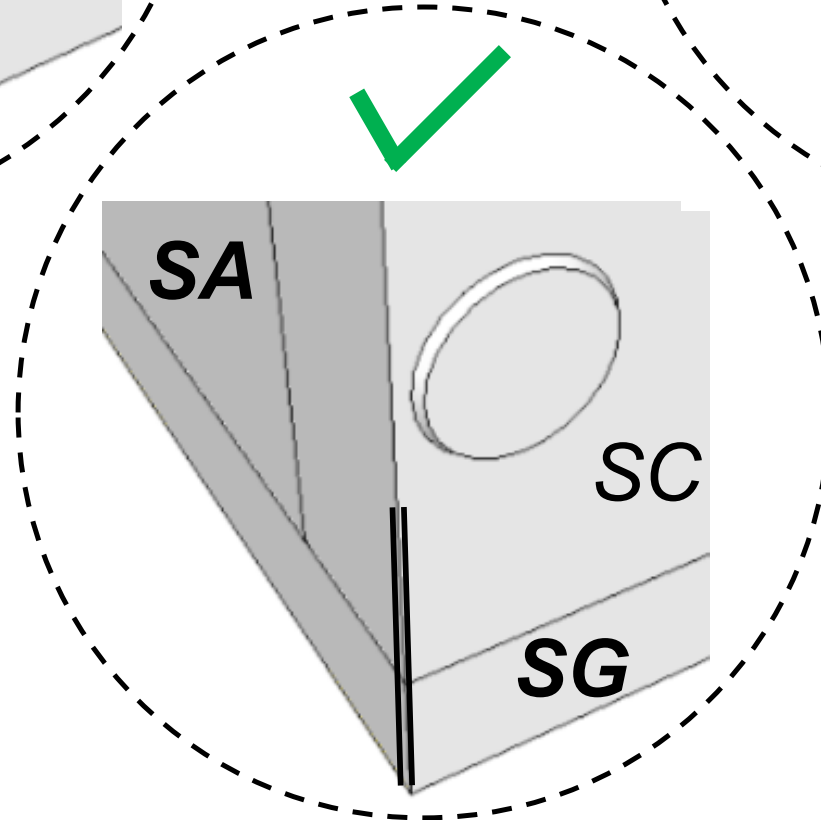
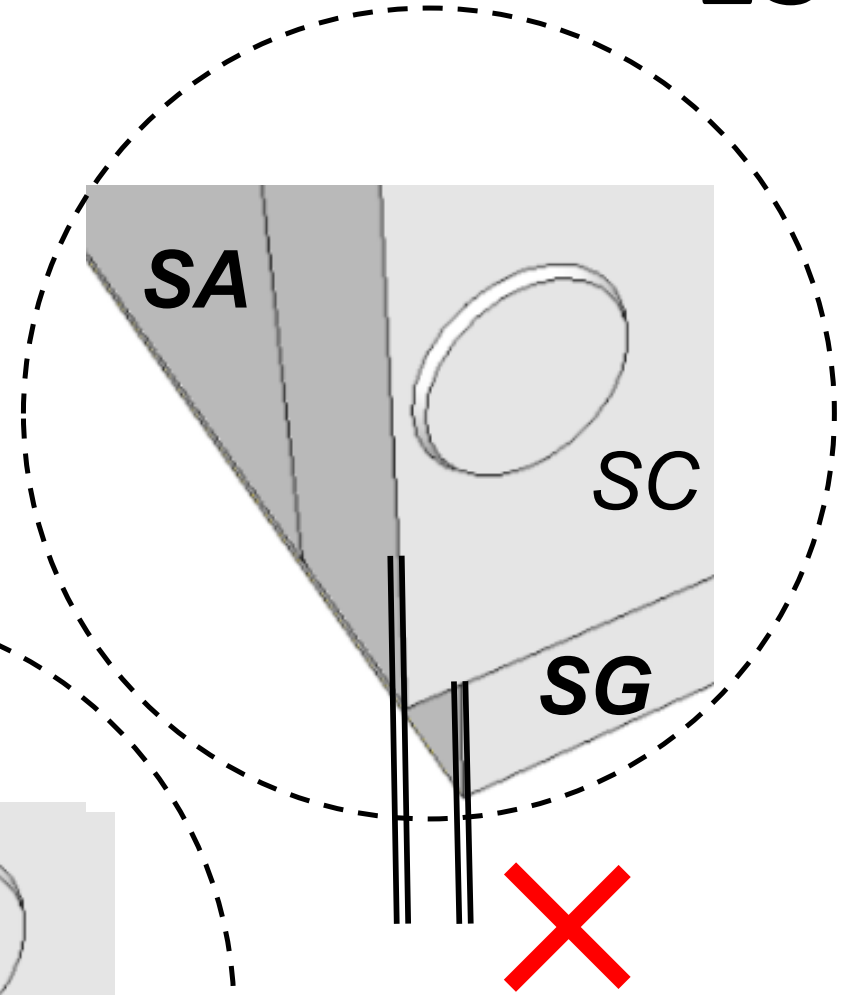
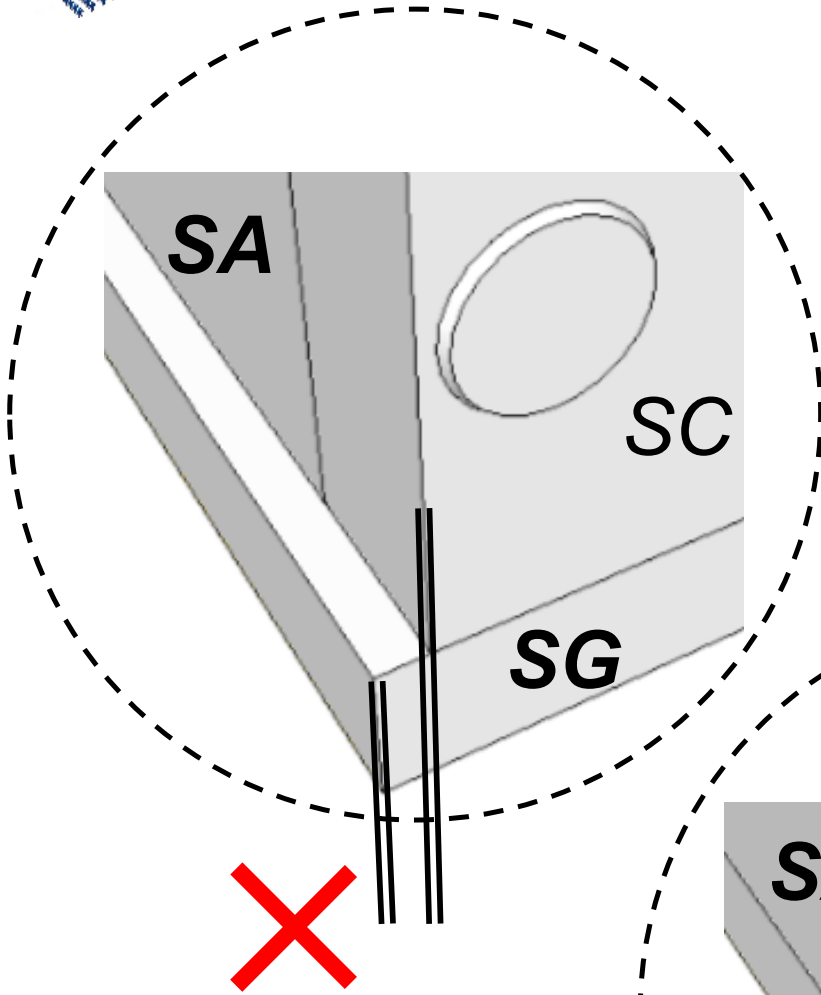



x 6

→ **Mettre le canapé à l'endroit, ouvrir le coffre et introduire les supports dans les trous prévus pour**

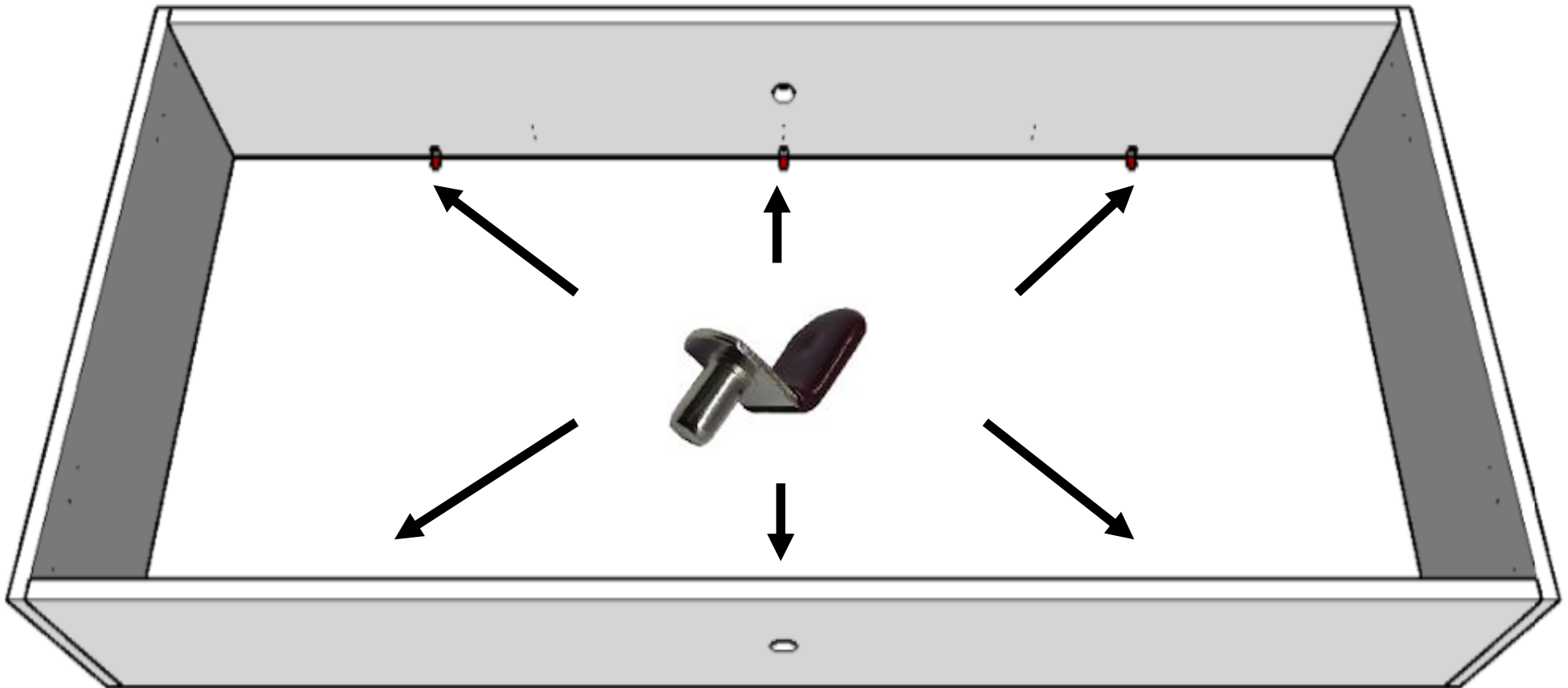

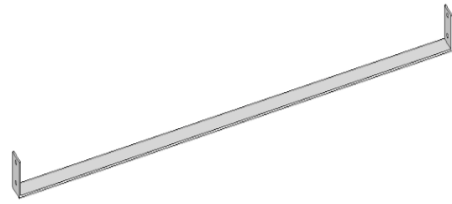

Renfort x 1

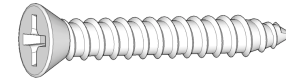

Vs2 x 4

- Poser la planche SF sur les supports
- Placer le renfort au centre et le visser

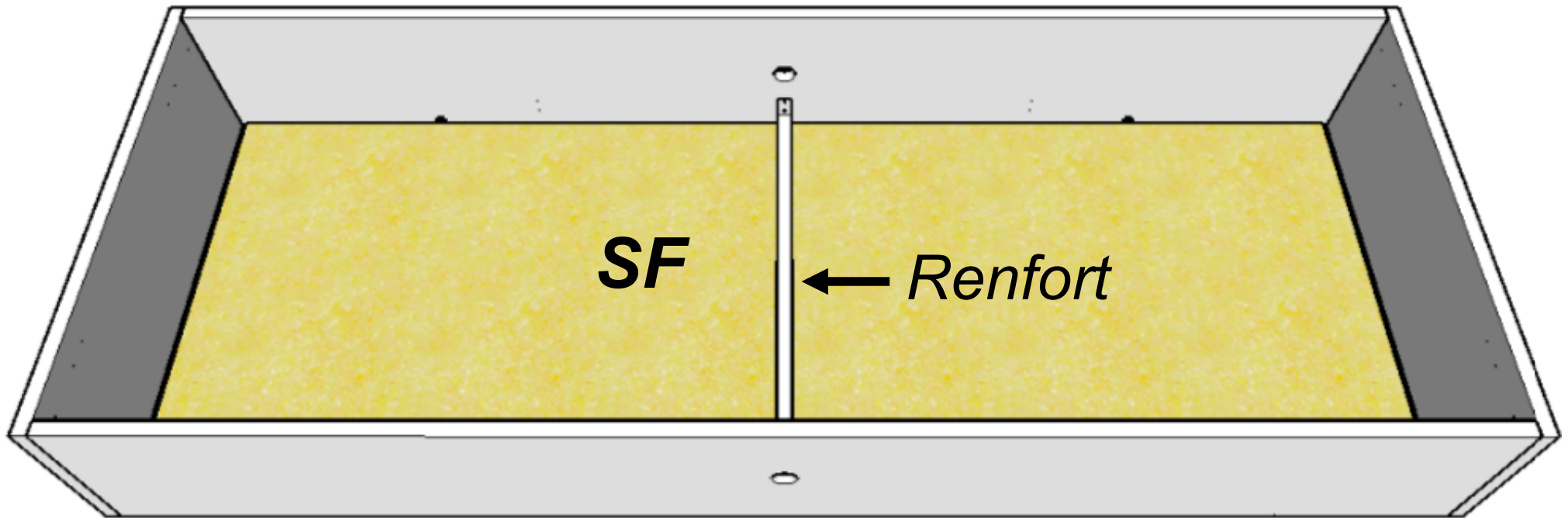



→ Insérer **AVEC FORCE** le port USB dans SA puis le visser par l'intérieur

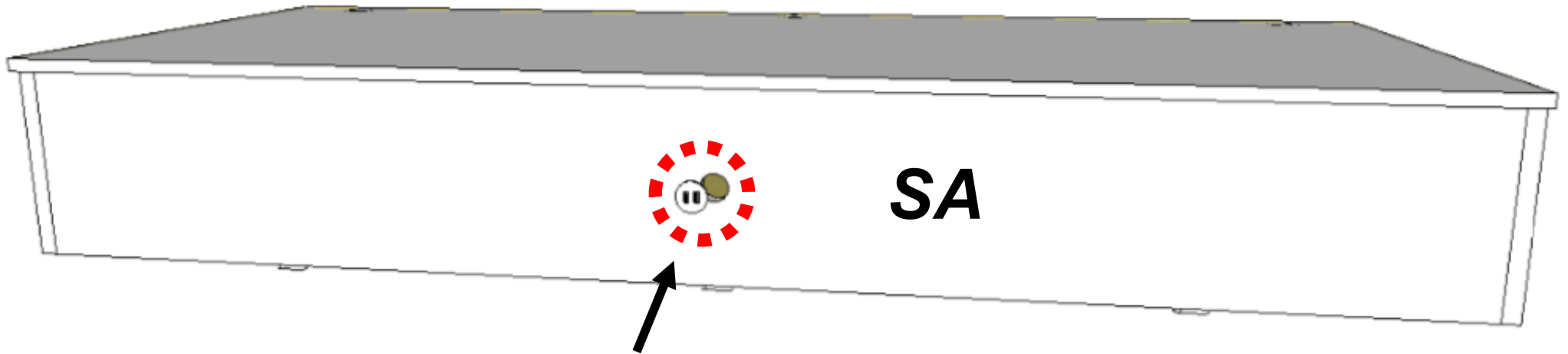

→ Poser l'assise en mousse sur le canapé